

J.L.Fisher

Motion Picture &
Television Equipment

MODEL 11 CAMERA DOLLY

OUR MOST COMPACT HYDRAULIC LIFT DOLLY

The Model 11 is our smallest Dolly. Lightweight and compact, it is built with the same high quality standards found in all J.L. Fisher products. The Model 11 Dolly shares the same controls and characteristics of the Model 10 Dolly and has a complete line of its own accessories. It operates effortlessly on Square or Round Track, making the Model 11 and Model 10 an excellent two dolly combination.

200 LB (91kg) LIFT BEAM CAPACITY



The Model 11 Dolly is engineered and manufactured to meet the demanding production needs of the motion picture, television and video industries. Compact size, three-way steering and a solid lift beam give operators a wide variety of options. The reliable, quiet, smooth and safe Model 11 requires minimal maintenance.

STEERING MODES

REAR (CONVENTIONAL):
Front wheels are locked, rear wheels can rotate 360°.

CRAB: Front and rear wheels can rotate in unison 360°.

ROUND: Front and rear wheels rotate independently with mechanical compensation to allow variable radius turns, even down to 0 radius.

NARROW: Front and rear wheels can rotate 180° in any steering mode, providing a narrower wheel track for working in tight spaces.

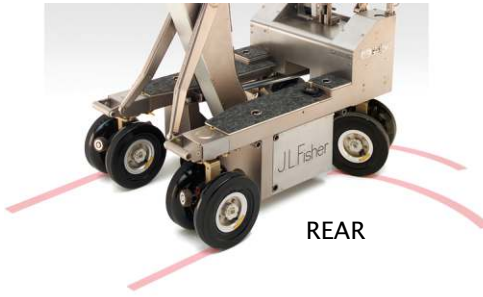

REAR

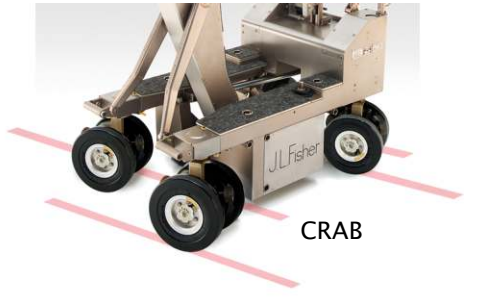

CRAB

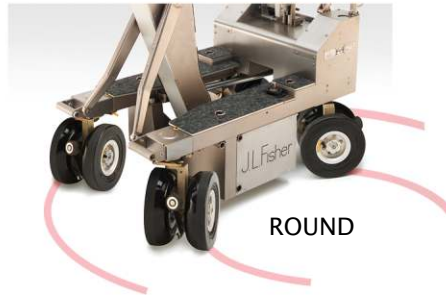

ROUND

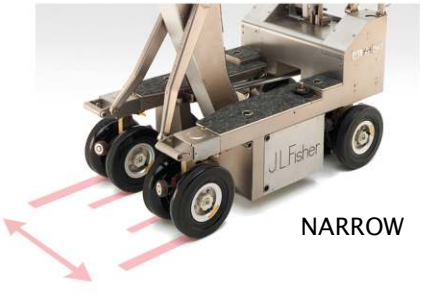

NARROW

ACCEPTS 90 TO 240 VOLTS AC OR DC TO CHARGE THE HYDRAULIC LIFT SYSTEM IN AS LITTLE AS THREE MINUTES

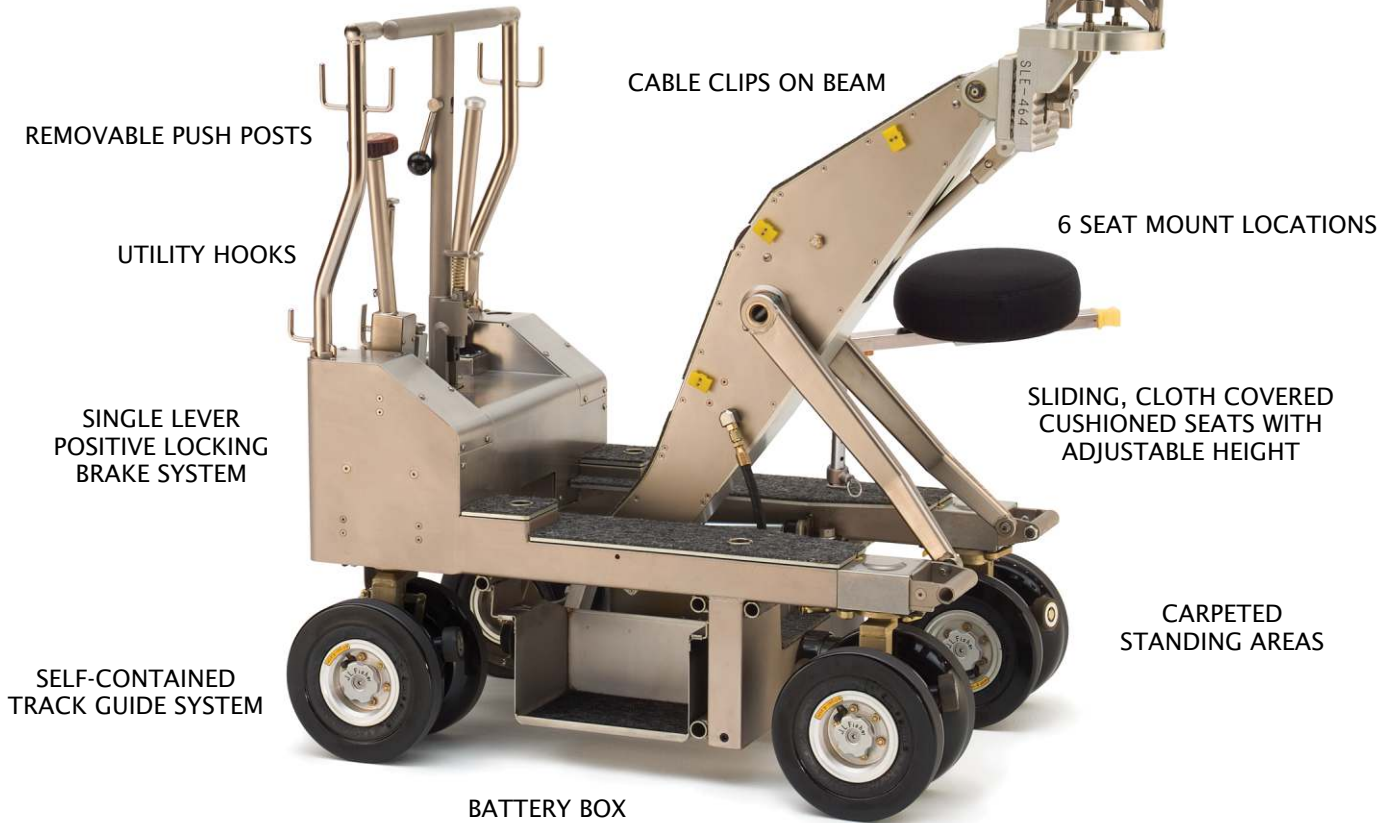

PUSH POSTS DOUBLE AS REAR CARRY HANDLES



POSITIVE LOCKING BRAKES



BUILT-IN TRACK GUIDES (Square Track Only)



MITCHELL MOUNT LEVELING HEAD WITH 4 WAY ADJUSTMENT AND 360° ADJUSTABLE DIAMOND PLATE



NEW CUE BOX WITH VARIABLE LIFT RATE MEMORY STOPS AND ADJUSTABLE DRAG KNOB



LEVELING HEAD CAN BE REVERSED



SELF CENTERING HYDRAULIC LIFT BEAM CONTROL KNOB WITH SAFETY LOCK

SEVEN LIFTS PER SYSTEM CHARGE

SELF-BLEEDING HYDRAULIC SYSTEM

200 lb (91kg) LIFT BEAM CAPACITY

LIFT BEAM POSITION (CUE) INDICATOR

SELF-DAMPENING LIFT BEAM SYSTEM



OPTIONAL UP/DOWN LEVER WITH SAFETY LOCK

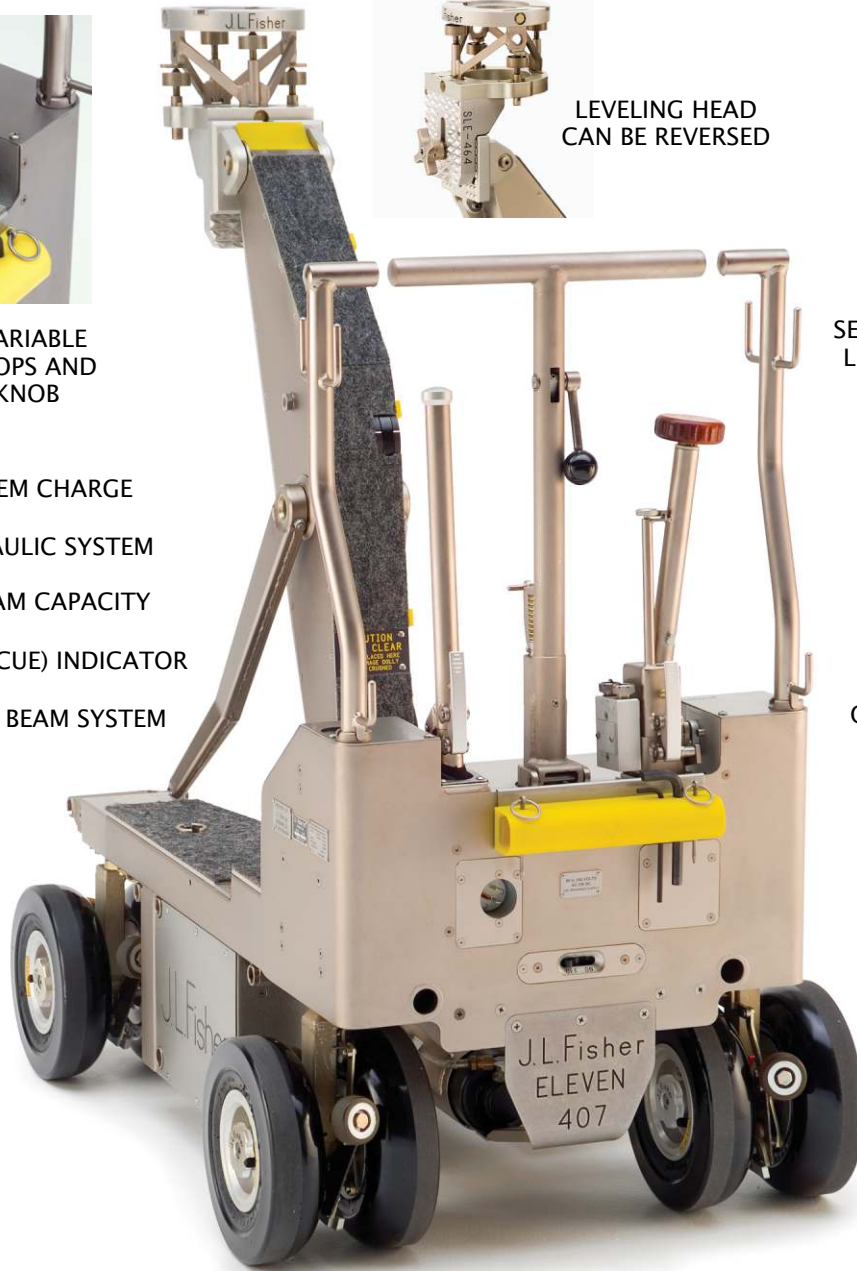

PNEUMATIC TIRES

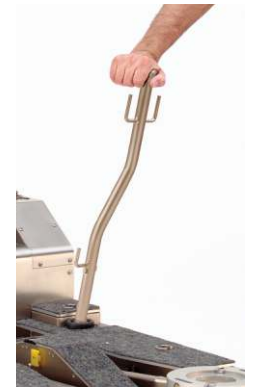

HYDRAULIC HAND PUMP FOR LOCATION WORK

The Model 11 Dolly has a maximum load capacity of 900 lbs. (408 kg)



LIFT BEAM (CUE) INDICATOR



Power Requirements:
90 TO 240 VOLTS AC OR DC

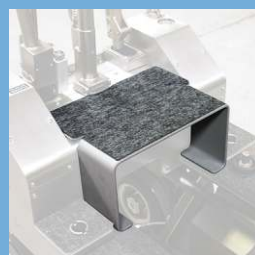

UTILITY TRAY (UTE)



FOLDING CONTROLS

STANDARD RENTAL PACKAGE

The Standard Rental Package includes these items:

- 1 SLE 4-way Level Head
- 1 HS Hand Screw (for SLE)
- 1 ST Small Seat
- 1 S Large Seat
- 2 PP Push Posts
- 2 LE Low Side Boards
- 2 FE Front Boards
- 2 HE High Side Boards
- 2 CH Carry Handles
- 1 PC Power Cord
- 2 FPIN Front Pins
- 1 BPR Knee Bumper
- 2 AWR Allen Wrenches
- 8 TSW Pneumatic Tires
- 1 BRE Battery Box

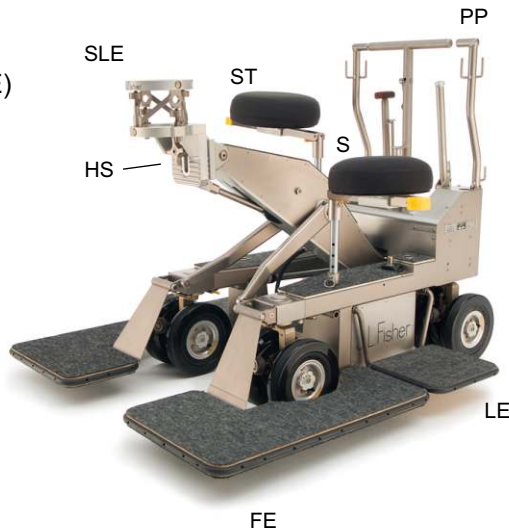

OPTIONAL ACCESSORIES

*Asterisk indicates items are included in the **FULL RENTAL PACKAGE**

Dolly Boards & Platforms

- SPE* Standing Platform
- DEL* Diving Board, Left
- DER* Diving Board, Right
- EFB* Front Board Bridge
- SFB Short Front Board
- SNFB Short Narrow Front Board
- FPE Front Porch
- RPE Front Porch Running Board (2)
- LFBE Low Front Board

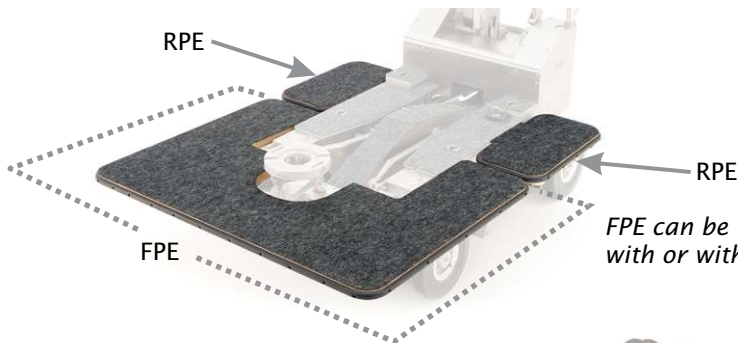
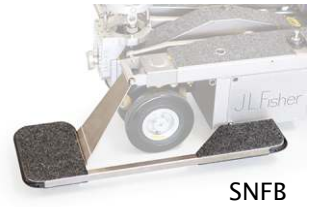

FPE can be used with or without RPE



Popular Accessories

- AC* Accessory Carts (pair)
- PB Push Bar
- UDJ Dolly Jack (uses Push Post for handle)
- UTE Utility Tray (Eleven Dolly)

AC* (pair)



UDJ



UTE

MORE OPTIONAL ACCESSORIES

*Asterisk indicates items are included in the FULL RENTAL PACKAGE

Risers

- R3 Camera Riser, 3" (7.6cm)
- R6* Camera Riser, 6" (15.2cm)
- R12* Camera Riser, 12" (30.5cm)
- R6BA Camera Riser w/ 75mm Ball Adapter, 6" (15.2cm)
- R6BB Camera Riser w/ 100mm Ball Adapter, 6" (15.2cm)
- R6BC Camera Riser w/ 150mm Ball Adapter, 6" (15.2cm)
- R12BA Camera Riser w/ 75mm Ball Adapter, 12" (30.5cm)
- R12BB Camera Riser w/ 100mm Ball Adapter, 12" (30.5cm)
- R12BC Camera Riser w/ 150mm Ball Adapter, 12" (30.5cm)
- RJ6 Heavy Duty Camera Riser, 6" (15.2cm)
- RJ12 Heavy Duty Camera Riser, 12" (30.5cm)
- RJ18 Heavy Duty Camera Riser, 18" (45.7cm)



R3 R6* R12*



R6BA R6BB R6BC R12BA R12BB R12BC RJ6 RJ12 RJ18

Angle Plate

- AP* 90-Degree Camera Angle Plate

AP*



Offsets

- U* Camera Offset, 10" (25.4cm)
- TH Camera Offset, 24" (61cm)
- RO* Rotating Offset
- ROB Rotating Offset w/ Ball Adapter, 150mm
- ROL Rotating Offset, Low
- ROHL Rotating Offset, High/Low
- ROX Rotating Offset, Long
- ROXL Rotating Offset, Long, Low
- ROP Rotating Offset, Pivot

U*



U (Heavy Duty)



TH



TH (Heavy Duty)



RO*



ROB



ROL



ROX



ROHL



ROXL



ROP



Adapters

- 75A 75mm Ball Adapter
- 100A 100mm Ball Adapter
- 150A 150mm Ball Adapter
- UA Universal Adapter
- HBA Half-Ball Adapter
- MEA Mitchell Euro Adapter
- ESLE Euro Boss Adapter

75A



100A



150A



UA



HBA



MEA



ESLE



Low Level Head

- LHE* 4-way Low Level Head
- LHA Low Head Adapter

LHE*



LHA



Seat & Seat Accessories

- RS Rotating Seat
- SOH* Seat Offset High
- SOS Seat Offset Straight
- SSOS Seat Offset Short
- SR6* Seat Riser Adjustable

RS



SOH*



SOS



SSOS



SR6*



MORE OPTIONAL ACCESSORIES

Jib Arms

- JIB20* Model 20 Jib Arm, 51.5" (131cm) Reach
- JIB21* Model 21 Jib Arm, 68.5" (174cm) Reach
- JIB22* Model 22 Jib Arm, 99.5" (253cm) Reach



JIB21

Please refer to the Jib Arm Brochure or our web site, www.jlfisher.com, for full specifications and options available

* Note: Model 20, 21 and 22 Jib Arms require the use of the Center Mount (CM) and RJ12 Heavy Duty Riser on the Model 11 Dolly

Crossarms

- CRA1 Crossarm, 11.5" (29cm) to 19" (48cm) Reach
- CRA2 Crossarm, 15" (38cm) to 24" (61cm) Reach
- CRA3 Crossarm, 18" (46cm) to 29" (74cm) Reach
- CRA4 Crossarm, 23" (58cm) to 36" (91cm) Reach
- CRA6 Crossarm, 31" (79cm) to 53" (135cm) Reach



CRA4

Please refer to the Crossarm Brochure or our web site, www.jlfisher.com, for full specifications and options available

Fluid Heads

- WS2 Weaver/Steadman Fluid Head, 2 Axis
- WS3 Weaver/Steadman Fluid Head, 3 Axis
- V Vector 700 Fluid Head, 2 Axis



WS2

WS3

V

Other Accessories

- BAZ Bazooka (Pneumatic or Sectional)
- CHE Short Carry Handles
- CM Center Mount with RJ12 Riser
- CB Cue Board
- HH High Hat
- LA Lamp Adapter
- MLA Mitchell Lamp Adapter, Junior 1 1/8" in.

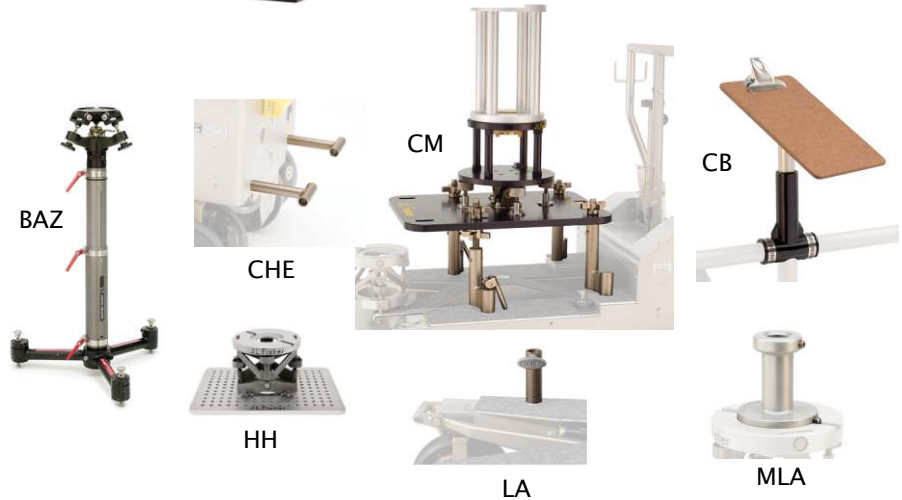

BAZ

CHE

CM

CB

HH

LA

MLA

- SCOA Scooter Board with Articulating Wheels
 - 4-sets Articulating Wheels
 - Mitchell Mount
 - 4-Tie downs
 - 4-Speed rail receivers
 - 4-Carrying handles
 - 44-3/8" pre drilled holes for high hats and other accessories
 - 3-Tripod foot locators
 - 34 1/2" W x 53" L



SCOA



SCOA and SBWS
All 32 wheels maintain contact on both straight and curved round track.

Wheels & Ice Skates

- SHW Shaved Wheel
- SKE Ice Skates
- ETW* Round Track Wheels with Positive Locking Brakes
- SCWE Soft Compound Wheels
- SWE Soft Wheels
- SBWS Skateboard Wheels
- DSBC Dexter Skateboard Wheels



SHW

SKE

ETW*

SCWE

SWE

SBWS / DSBC

* ETW Wheels NOT recommended for use on CR10 (10' diameter Round Track). Skateboard Wheels SBWS recommended instead.

Track & Track Accessories

Straight Track sections fold from 24.5" wide to 5" wide for easy transport and storage

Straight Track

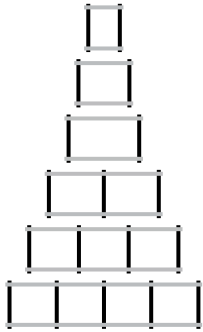

	Length	Length (folded)	Weight
TR2	2' (.61m)	4.1' (1.3m)	11.8 lbs (5.4kg)
TR3	3' (.91m)	5.1' (1.6m)	15.0 lbs (6.8kg)
TR4	4' (1.2m)	6.1' (1.9m)	16.2 lbs (7.3kg)
TR6	6' (1.8m)	8.1' (2.5m)	23.8 lbs (10.8kg)
TR	8' (2.4m)	10.1' (3.0m)	30.2 lbs (13.7kg)
TR10	10' (3m)	12.1' (3.7m)	38.0 lbs (17.2kg)

○ Round Tube Track 1.5" (3.8cm) Diameter

All J.L. Fisher track is on 24.5" (62.23cm) center line between rails.

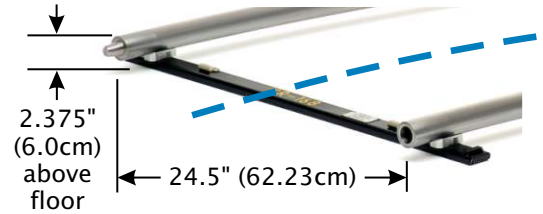

Curved Track Diameters are Measured from Centerline Between Rails

Square tube dolly track, not shown here, is available in similar sizes and diameters as the round tube track. Please call J.L. Fisher for sizes and availability.



TS Track Support



Curved Track

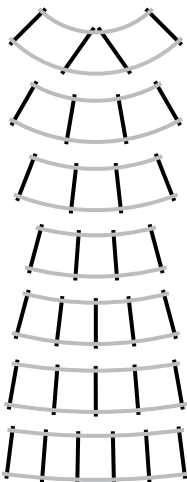

	Diameter Full Circle	Angle Section	Sections For Full Circle	Length* Section	Width* Section	Weight Section
CR10	10' (3m)	90°	4	8.7 ft (2.7m)	3.2 ft (.96m)	31.2 lbs (14.2kg)
CR15	15' (4.6m)	60°	6	8.5 ft (2.6m)	3.1 ft (.94m)	30.5 lbs (13.8kg)
CR	20' (6.1m)	45°	8	7.8 ft (2.4m)	3.0 ft (.91m)	29.0 lbs (13.2kg)
CR25	25' (7.6m)	30°	12	7.1 ft (2.2m)	2.8 ft (.85m)	27.8 lbs (12.6kg)
CR30	30' (9.1m)	30°	12	8.4 ft (2.6m)	2.9 ft (.88m)	33.8 lbs (15.3kg)
CR50	50' (15.2m)	20°	18	9.2 ft (2.8m)	2.8 ft (.85m)	34.5 lbs (15.6kg)
CR70	70' (21.3m)	15°	24	9.5 ft (2.9m)	2.8 ft (.85m)	38.8 lbs (17.6kg)

* Example

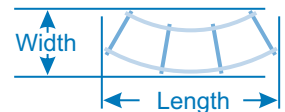

RMPR Track Ramp For Round Track
WED Track Wedges
TB Track Buckle

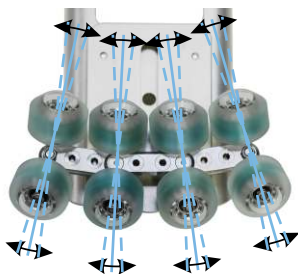

EACH SET OF 2 WHEELS (TRUCK) CAN SWIVEL INDEPENDENTLY



Model 11 Dolly shown using Built-in Track Guides on Square Curved Track (CS2)



NEW SKATEBOARD WHEELS (SBWS) (Patents Pending) come with extensions to allow the Model 11 Dolly to be mounted sideways on the wheel frame. Shown here with the extensions in place, the LOW HEAD ADAPTER (LHA) and the LOW LEVEL HEAD (LHE) on Round Straight Track (TR10)



TRACK WHEELS (ETW) ON ROUND TRACK (TR)



BUILT-IN TRACK GUIDES ON SQUARE TRACK (STR)

Maximum Lift Beam Elevation	51.25 in. (130 cm)
Minimum Elevation (standard head).....	13.875 in. (35 cm)
Minimum Elevation (low level head).....	3 in. (8 cm)
Vertical Beam Travel	33.375 in. (85 cm)
Lift Beam Capacity	200 pounds (90.72 kg)
Lifts per System Charge.....	7
Length	40 in. (102 cm)
Width (wheels in)	20.5 in. (52 cm)
Width (wheels out)	25.625 in. (65 cm)
Height (operating).....	39.75 in. (101 cm)
Height (folded)	23.5 in. (60 cm)
Height (center mount, before riser)	36.75 in. (93 cm)
Minimum Turn Radius (round steering)	16.188 in. (41 cm)
Minimum Turn Radius (conventional steering).....	33.5 in. (85 cm)
Maximum Dolly Load Capacity.....	900 pounds (408.23 kg)
Battery Box (BRE) inside dimensions	10 in. (25.4 cm) W x 7 in. (17.8 cm) H x 6.75 in. (17.1 cm) D
Carrying Weight	316 pounds (143.33 kg)
Crated Size	59 in. (150 cm) L x 31 in. (79 cm) W x 34 in. (86 cm) H
Crated Weight	775 pounds (351.5 kg) (standard package)

DIMENSIONS

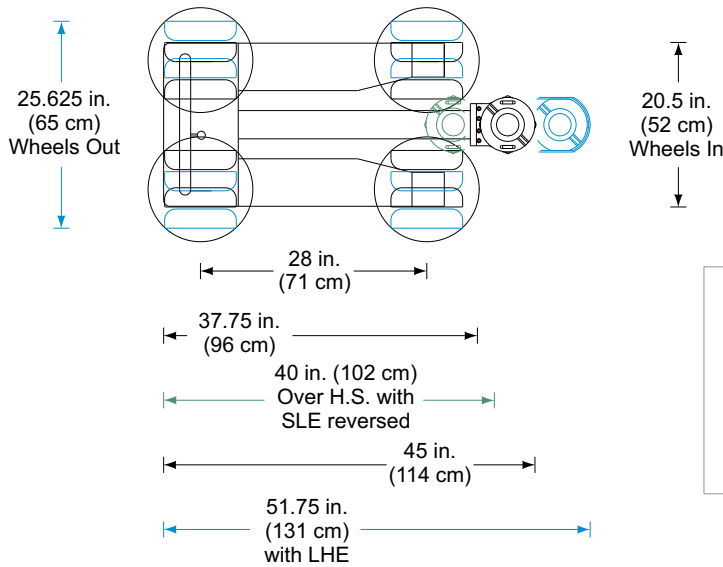

Note: Due to variables such as adjustments and choice of risers, wheels, etc., these dimensions are approximate.

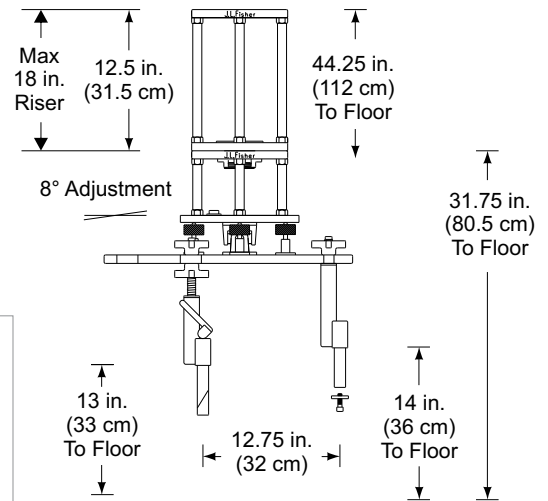

CENTER MOUNT (CM)

The Center Mount (CM), supports jib arms, lightweight camera booms and counterbalanced camera cranes. The Center Mount has thumbscrews for four-way leveling adjustment and a leveling indicator. Easily installed, the Center Mount has a standard Mitchell mount and comes with a heavy duty 12-inch Riser (RJ12).

The maximum gross load capacity of the Model 11 Dolly is 900 pounds (408 kg). Center Mount is not for supporting personnel or personnel carrying cranes.

MODEL 11 DOLLY

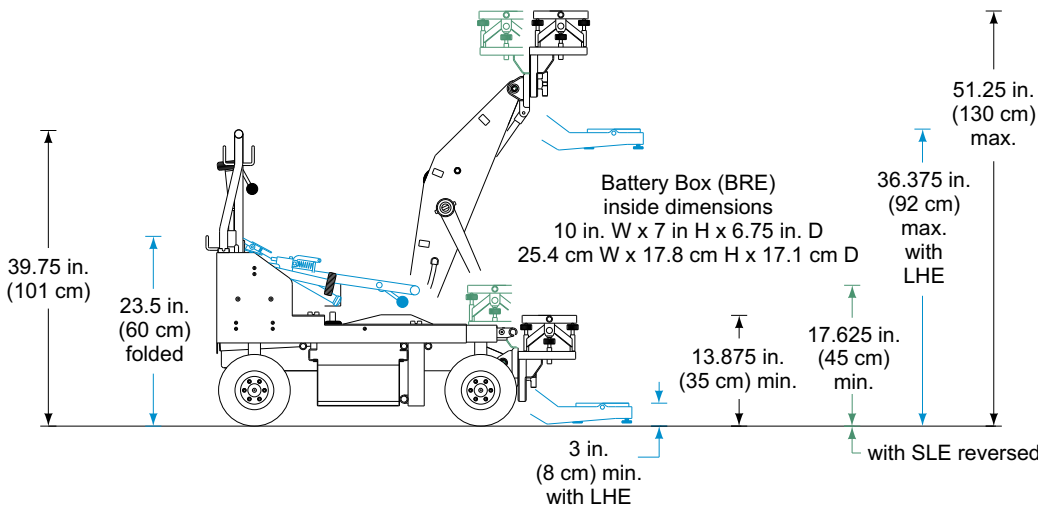

FOLDING CONTROLS

J.L. FISHER PRODUCTS ARE PROUDLY MADE IN BURBANK, CALIFORNIA U.S.A.

J.L. Fisher, Inc. Motion Picture & Television Equipment
 1000 W. Isabel Street, Burbank, CA 91506 U.S.A.
 Tel: (818) 846-8366 / Fax: (818) 846-8699
 Web: www.jlfisher.com e-mail: info@jlfisher.com

J.L. Fisher, GmbH Emil-Hoffmann-Str. 55-59 50996 Köln, Germany
 Tel: +49 2236 3922 0 Fax: +49 2236 3922 12
 Web: www.jlfisher.de e-mail: info@jlfisher.de